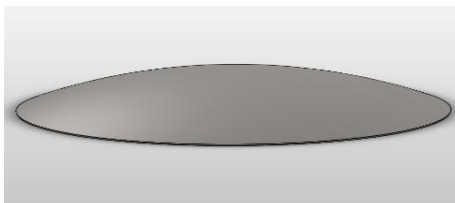
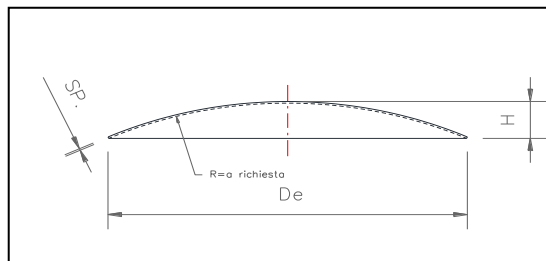
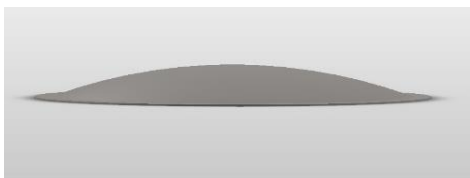
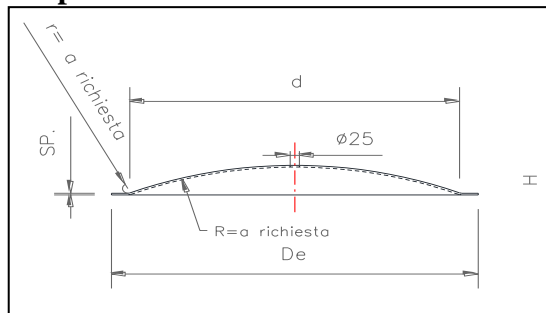
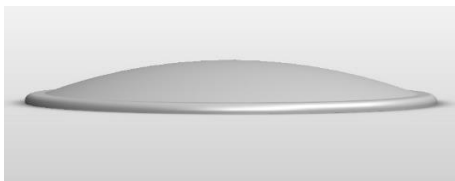

Produzione Fondi BOMBATI-PIANI-CONICI-EMISFERICI**CALOTTA Tipo "A"**

De (mm) 0-5000
SP.(mm) 1,5 a 40
R(mm) a richiesta
H(mm) a richiesta
Foro centrale a richiesta

**CALOTTA SPIANATA Tipo "B"**

De (mm) 0-5000
SP.(mm) 1,5 a 25
R(mm) a richiesta
r(mm) a richiesta
H(mm) a richiesta
Foro centrale a richiesta

**CALOTTA SPIANATA E RAGGIATA Tipo "BB"**

De (mm) 0-5000
SP.(mm) 1,5 a 25
R(mm) a richiesta
r(mm) a richiesta
H(mm) a richiesta
Foro centrale a richiesta

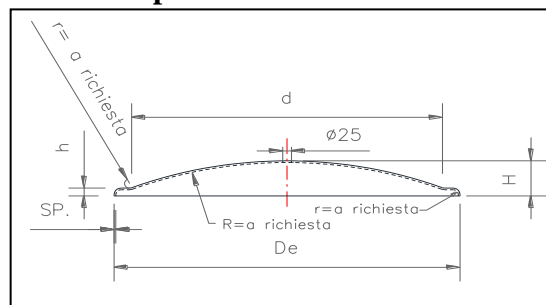

FONDO PIANO BORDATO Tipo "C"

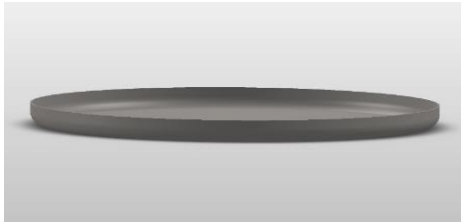

De (mm) 0-5000
SP.(mm) 1,5 a 25
r(mm) a richiesta
H(mm) a richiesta
Foro centrale a richiesta

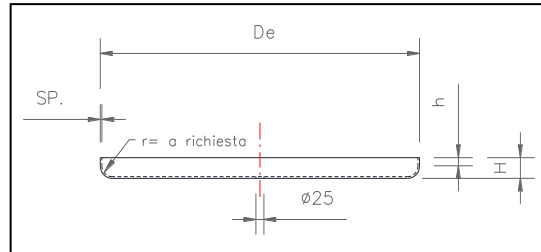

FONDO PIANO BORDATO Tipo "CA"



De (mm) 0-5000
SP.(mm) 1,5 a 30
r(mm) a richiesta
h(mm) a richiesta
H(mm) a richiesta
r2(mm) a richiesta
h2(mm) a richiesta
d (mm) a richiesta

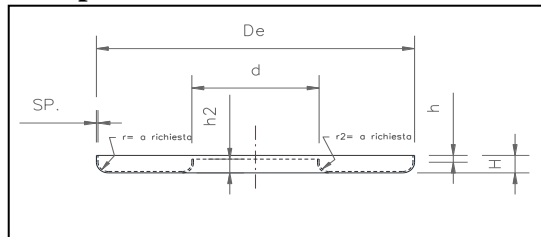

FONDO PIANO BORDATO Tipo "CB"

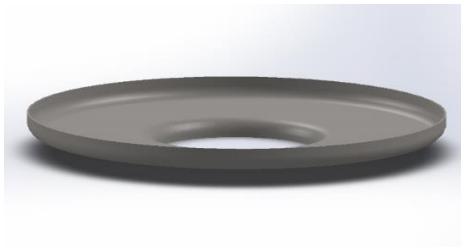

De (mm) 0-5000
SP.(mm) 1,5 a 30
r(mm) a richiesta
h(mm) a richiesta
H(mm) a richiesta
r2(mm) a richiesta
h2(mm) a richiesta
d (mm) a richiesta

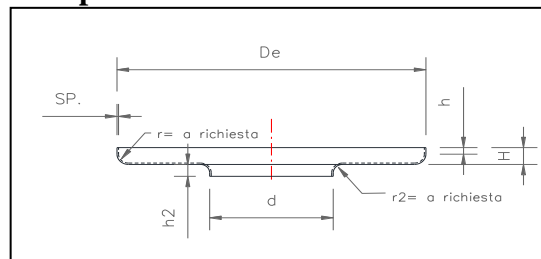

FONDO CONVESSO BORDATO Tipo "D"

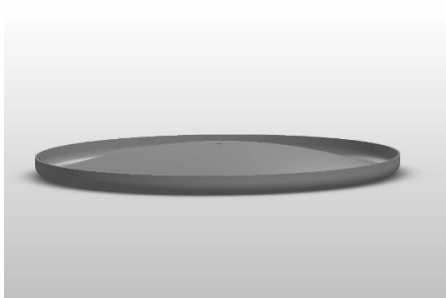

De (mm) 0-5000
SP.(mm) 1,5 a 25
R(mm) a richiesta
r(mm) a richiesta
h(mm) a richiesta
H(mm) a richiesta
Foro centrale a richiesta

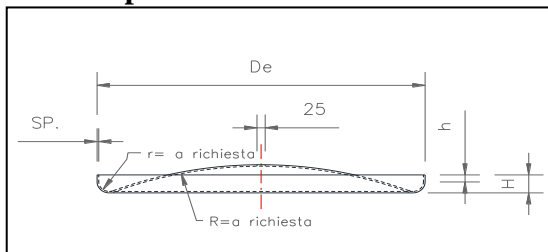

FONDO BOMBATO E BORDATO CONCAVO BASSA BOMBATURA Tipo "E"

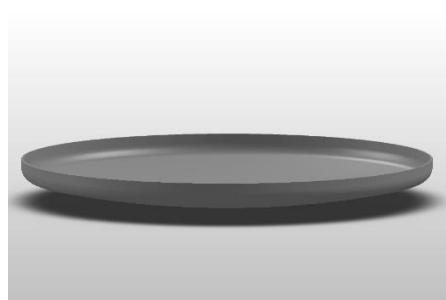

De (mm) 0-5000
SP.(mm) 1,5 a 25
R(mm) = $1,5D / 2D$
r(mm) a richiesta
h(mm) a richiesta
H(mm) a richiesta
Foro centrale a richiesta

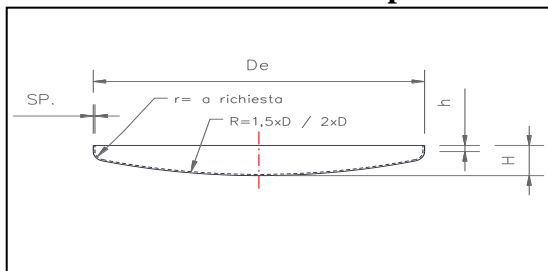

FONDO BOMBATO E BORDATO DECINORMALE Tipo "G"

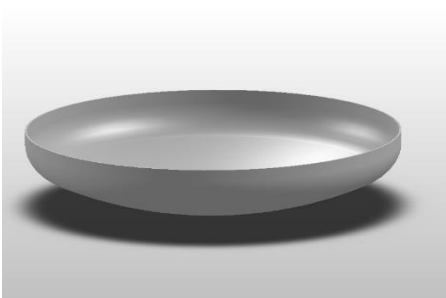

De (mm) 0-5000
SP.(mm) 1,5 a 25
R(mm) = D
r(mm) D/10
h(mm) a richiesta
H(mm) a richiesta
Foro centrale 25mm

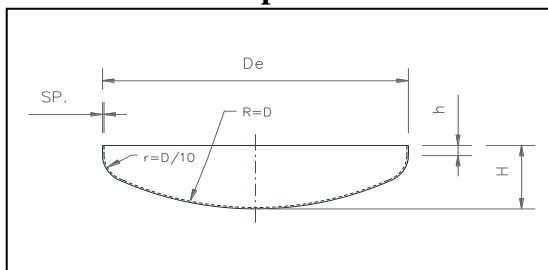

FONDO BOMBATO E BORDATO PSEUDO ELLITTICO Tipo "H"

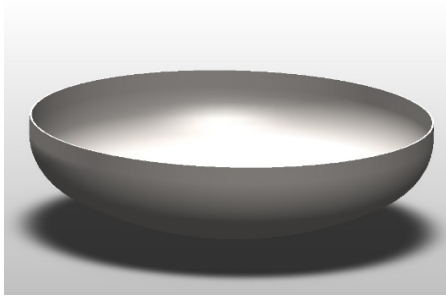

De (mm)	0-5000
SP.(mm)	2,5 a 30
R(mm)	= 0,8D
r(mm)	D/6,5
h(mm)	a richiesta
H(mm)	a richiesta
Foro centrale	25mm

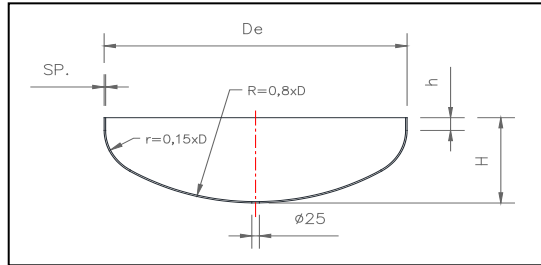

FONDO BOMBATO EMISFERICO Tipo "I"

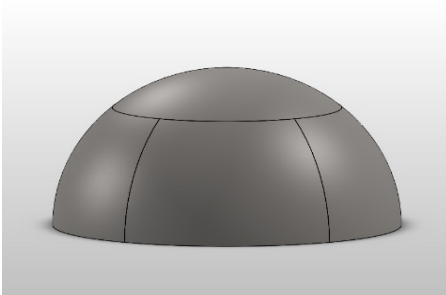

De (mm)	0-5000
SP.(mm)	2,5 a 25
R(mm)	= D/2
H(mm)	a richiesta
Calotta D	da valutare
n° Spicchi	da valutare
Foro centrale	CIECO

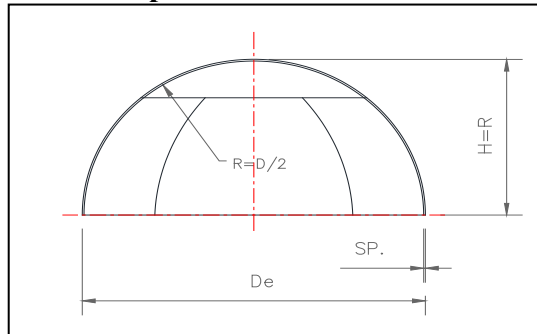

FONDO CONICO BORDATO Tipo "LB"

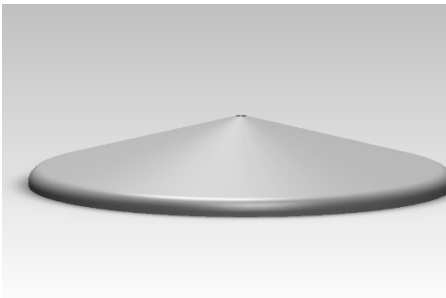

De (mm)	0-5000
SP.(mm)	1,5 a 22
r(mm)	a richiesta
h(mm)	a richiesta
H(mm)	a richiesta
Foro centrale	a richiesta

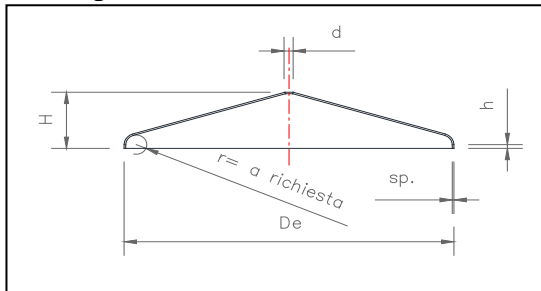

FONDO CONICO BORDATO Tipo "LA"

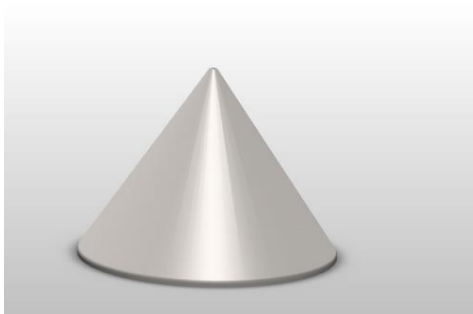

- De (mm)** 0-5000
- SP.(mm)** 1,5 a 15
- r(mm)** a richiesta
- h(mm)** a richiesta
- H(mm)** a richiesta
- Anglo (°)** a richiesta
- Foro centrale** a richiesta

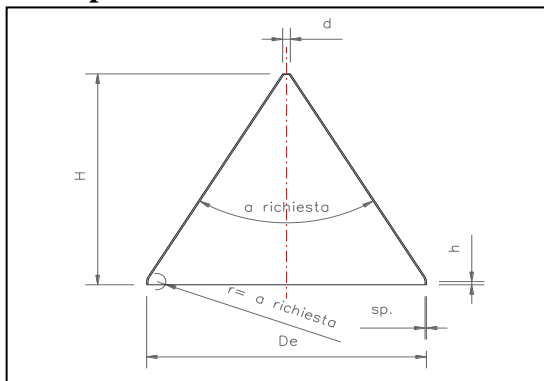

FONDO CONICO BORDATO Tipo "LC"

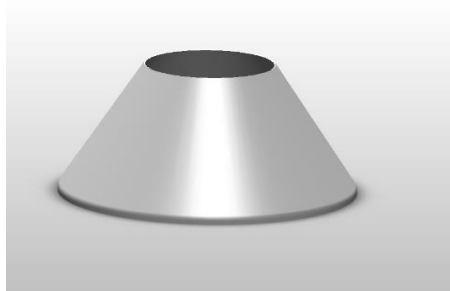

- De (mm)** 0-5000
- SP.(mm)** 1,5 a 20
- r(mm)** a richiesta
- h(mm)** a richiesta
- H(mm)** a richiesta
- Anglo (°)** a richiesta
- Foro centrale** a richiesta

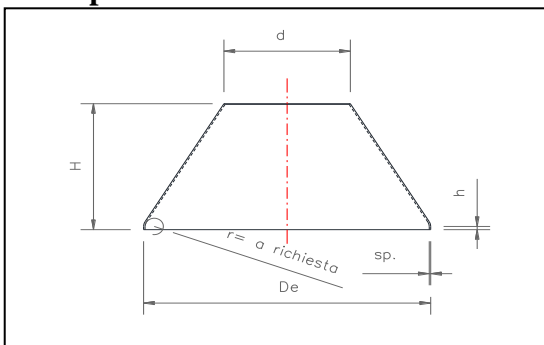

FONDO CONICO BORDATO Tipo "LD"

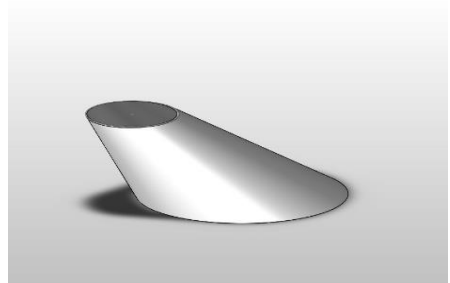

- De (mm)** 0-5000
- SP.(mm)** 2,5 a 20
- r(mm)** a richiesta
- h(mm)** a richiesta
- H(mm)** a richiesta
- Anglo (°)** a richiesta
- Foro centrale** a richiesta

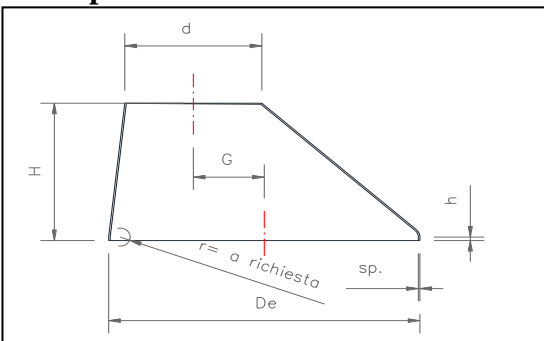



dal 1968 in continua evoluzione...

Produzione Fondi BOMBATI-PIANI-CONICI-EMISFERICI

Fondi conici con intercapedine Vapore/Freon



Fondo Bombato con intercapedine per Glicole



Fondo conico D=4200mm spessore 60/10



Fondo Emisferico Inox Ribassato D=3150 spessore 60/10



Fondo conico D=273m a d=60,3mm H=785mm spessore 30/10

Fondo conico D=50m a d=20mm H=200 mm spessore 15/10



Fondi Bombati R=D lucidato internamente

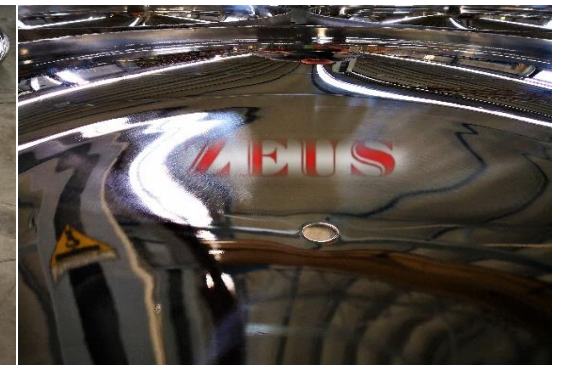

Doppio fondo conico d=20mm a D=50m a d=20mm H=430 mm spessore 15/10